

The new **ROWE** ecoPrint

Unique, Patented Technology.

6 Models

- i4
- i6
- i8 i8L
- i10 i10L



WIDE FORMAT: ROWE.

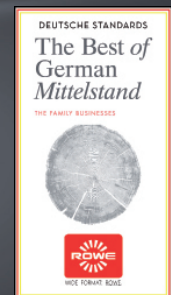

Multifunctional wide format printers. Made in Germany.



KEY HIGHLIGHTS AT A GLANCE.

CONTENT

Editorial	3	Printer Productivity	9	3 in 1 Online Folding System	16
Full Modularity	4 - 5	Ergonomics	10 - 11	Accessories	17
The Specialist for Large Format ..	5	Scanner Quality	12	Technical Data	18 - 19
ROWE APP CENTER	6	Scanner Productivity	13		
Intelligent Networking	7	Controller and Safety	14		
Printer Quality	8	Environmental Friendliness	15		

THE NEW ROWE ecoPrint

Latest technologies for productive large format printing.

Experience a new era in digital functionality with the future oriented ROWE ecoPrint. Previously unimaginable, as your business processes change, the full modularity of ROWE ecoPrint enables full adaptation to meet your business requirements, at any time. Yet another ground breaking development from ROWE - the new ROWE APP CENTER. Extend your software at any time. All Apps are perfectly tuned to one another in order to optimize your workflow.

Unique: The ROWE FULL HD USER-INTERFACE with a 23" or 24" multifunctional touchscreen. Never before have you worked so intuitively and effortlessly - two viewers (over and main) put you in control. ROWE has also completely revolutionized the roll change, it's now completely ergonomic - thanks to the patented ROWE MEDIA INPUT ASSISTANT.

Experience the fascination of ROWE. Simply make an appointment with the authorized dealer in your area.



Unrivalled compactness
Cloud integrated scanning,
copying and printing with up to 6
automatic rolls, All - in - One



Cloud-Integration, regardless of
where your documents are



Full Modularity

FULL MODULARITY. AT ANY TIME.

With 6 models and the most extensive range of configurations ROWE ecoPrint can be perfectly adapted to suit your business processes.



And ROWE doesn't stop there:

Your ROWE ecoPrint can be extended at any time even after installation. This unique flexibility opens up new perspectives. Absolute future-proof. Typically ROWE.

Overview:

The 6 ROWE ecoPrint models

MODEL	AUTOMATIC ROLLS	PRINTING SPEED
i4	2 rolls, 3rd roll upgradeable	4 meters per minute, 5.5 DIN A1/ANSI D documents per minute
i6	2 rolls, 3rd + 4th roll upgradeable	6 meters per minute, 8.0 DIN A1/ANSI D documents per minute
i8	4	8 meters per minute, 10.8 DIN A1/ANSI D documents per minute
i8L	6	8 meters per minute, 10.8 DIN A1/ANSI D documents per minute
i10	4	10 meters per minute, 12.5 DIN A1/ANSI D documents per minute
i10L	6	10 meters per minute, 12.5 DIN A1/ANSI D documents per minute

Revolutionary: Thanks to its modular construction the ROWE VarioFold Compact is as affordable in the online configuration as any standard offline folding machine.

NO EXPERIMENTS. NO COMPROMISES. ROWE.

ROWE is the specialist for large format.

Scanner, printer, controller, software and finishing have been developed and manufactured by ROWE. Due to optimal tuning ROWE products guarantee safe and efficient adaptation to your business processes.

Unrivalled. Multifunctional with the patented technologies of ROWE ScanMatrix⁺

ROWE ecoPrint can be extended at any time to an efficient multifunctional printer with the new ROWE Scan 450i. For razor-sharp color scans with 2400 x 1200 dpi optical resolution. ROWE Scan 450i is equipped with SuperSpeed USB 3.0 + RES, ROWE ScanCloud and the worldwide unique technologies of ROWE ScanMatrix⁺ as standard. Your advantage is scanning with the patented process ROWE DYNAMIC STITCHING, fully automatic transformation of originals with poor contrast into perfect scans, due to the image improvement technology ROWE PRO LOGIC and brilliant, natural colors as a result of ROWE SELECTED TRUE LIGHT.

Unmatched. ROWE ERGOTEC and ROWE MEDIA INPUT ASSISTANT (patented)

You have the choice: 2, 3, 4 or 6 automatic rolls and single sheet feed. ROWE ERGOTEC and ROWE MEDIA INPUT ASSISTANT are unrivalled in ease of operation and durability.

Extremely space-saving document delivery

ROWE FRONT DELIVERY TRAY (integrated top delivery tray) is installed at a comfortable operating height and doesn't take any additional space. Documents can be easily removed at the front. Additionally, the ROWE FRONT DELIVERY TRAY has a double function - simply tilt it back and use it as a scan delivery tray.

Unique. ROWE FULL HD USER-INTERFACE with a 23" or 24" multifunctional touchscreen

As a result of the absolutely intuitive user interface with standardized platform and the 23" or 24" multifunctional touchscreen ROWE ecoPrint clearly outclasses standard printers with 10"-15" user interfaces. Easy, effortless finger tip operation of your ROWE ecoPrint, the same as with your tablet or smart phone. Exceptionally practical: with the two viewers (overview and main) everything is under control.

Secure Cloud Integration. ROWE WEB CONNECT

The future begins now: opening, releasing and printing documents where the storage place is irrelevant. With ROWE WEB CONNECT simply scan to a cloud and print from it. ROWE ecoPrint operates as the hub for all projects so that team members can interact without barriers.

Universal. The new ROWE APP CENTER

A comprehensive selection of applications means individual configurations – at any time.

Worldwide innovation: ROWE VarioFold Compact – patented modularity

The ROWE VarioFold compact is the first folding system worldwide which can be converted to an online folding system at any time, at minimal expense.

Alternatively, the ROWE folding systems 721-1 and 721-4 provide ideal extensions to your ROWE ecoPrint.



ROWE APP CENTER.

EXPERIENCE A NEW ERA OF DIGITAL FUNCTIONALITY.

Discover a comprehensive range of applications in the new ROWE APP CENTER. Operation is absolutely intuitive due to its user-friendly design and standard platform. ROWE has developed all applications especially for optimization of your business processes. You decide about the configuration. A new world, called up at the touch of a button.



INTELLIGENT NETWORKING. WORLDWIDE.

Everywhere, leading companies, architects, engineers and governments rely on ROWE when they need to communicate internationally. Large multi-national corporations particularly those with an international office network, profit worldwide from the opportunities offered by ROWE ecoPrint.

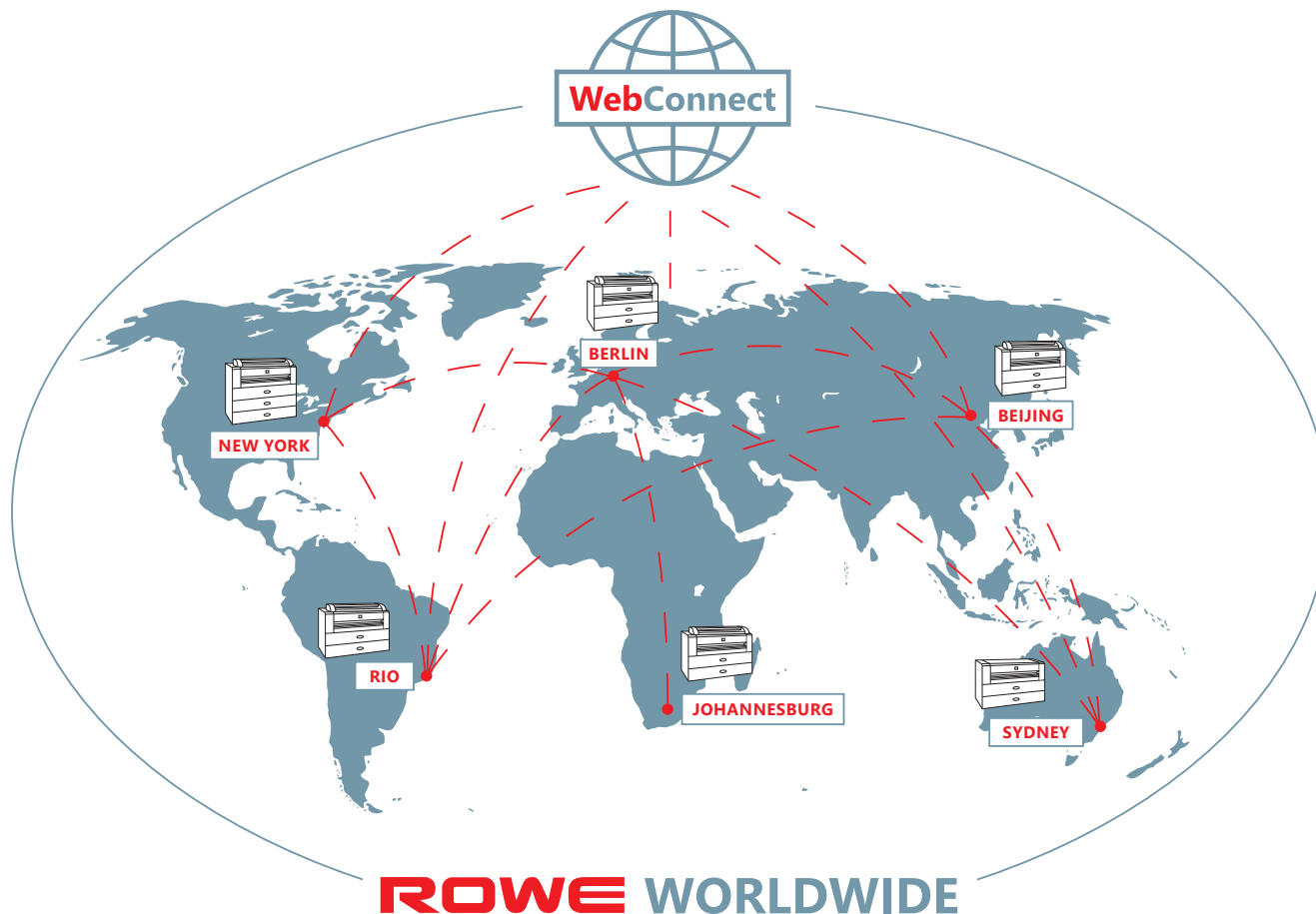

NO LIMITS!

The scalable Output Management Solution

Extend your possibilities at any time with the ROWE PRINT APP:

- Your printer environment can be operated in a completely uniform manner through additional print queues.
- Your printer environment isn't PS/PDF capable? No problem, with the PS/PDF print queue, printing can now be done directly.

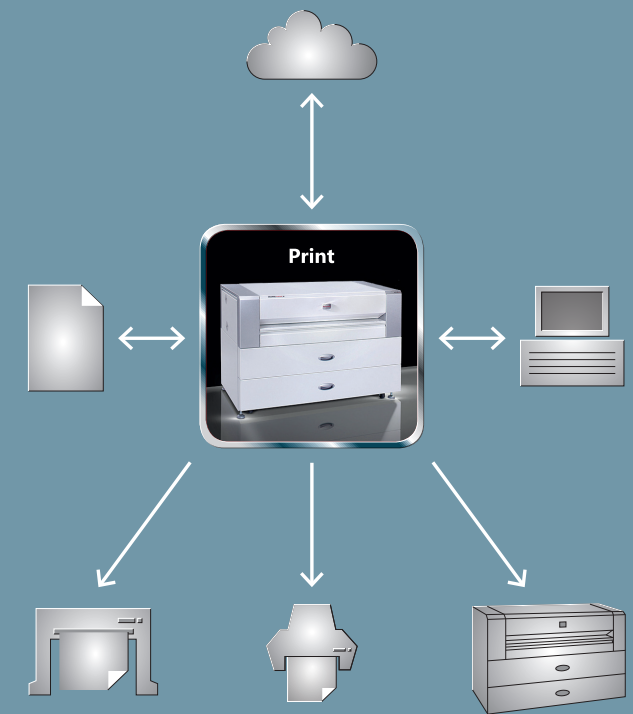

TRADITIONALLY ROWE IS THE LEADER IN QUALITY.

The new ROWE ecoPrint confirms this leading position.

Your competitive edge. ROWE SOLID PRINT TECHNOLOGY

Even large continuous black areas are printed uniformly – no loss of print quality even with high volumes.

Conventional printing systems

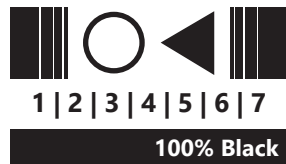

1st printout

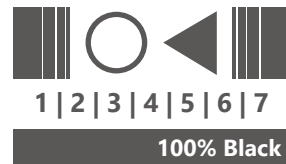

20th printout

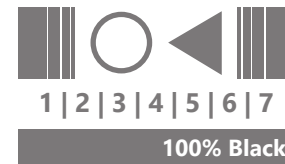

50th printout

ROWE SOLID PRINT TECHNOLOGY

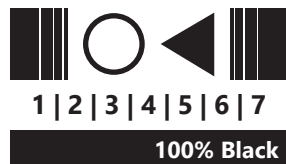

1st printout

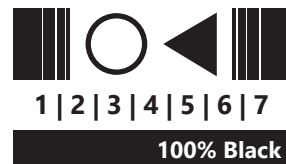

20th printout

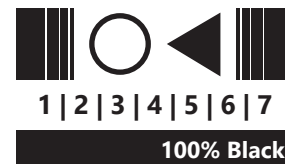

50th printout

Flat printed image. Optimal toner adhesion even when documents are folded

ROWE ecoPress is the ground breaking fusing technology, which solves a target conflict. Previously, lower energy consumption on the one hand and high fusing quality with optimal toner adhesion and a flat printed image on the other was considered to be a contradiction - previously! With ecoPRESS ROWE has provided an innovative fusing technology which copes with both a flat printed image, that can hardly be felt, optimal toner adhesion, even when documents are folded and all this with a power consumption of less than 41 watts in energy saving mode, including controller!

ROWE HIGH-Q-PRINT: 1200 x 600 dpi print quality

Thanks to highly developed image processing, the reproduction of lines is crystal clear and grey areas are reproduced homogenously as well as clearly.

MADE IN GERMANY.



Processing quality

ROWE has always had a name for maximum quality and durability. For this reason only those materials of particularly high quality are used in the manufacture of the new ROWE ecoPrint. The fully galvanized chassis meets the highest quality requirements.

100 % Made in Germany.

MAXIMUM-LEVEL PRODUCTIVITY.

As a specialist for large format we understand what it means to complete a printing job under high time pressure. This is why it is logical for ROWE to develop and manufacture scanner, printer, controller, software and finishing themselves. This ensures all modules are designed for maximum productivity and optimally tuned to one another.

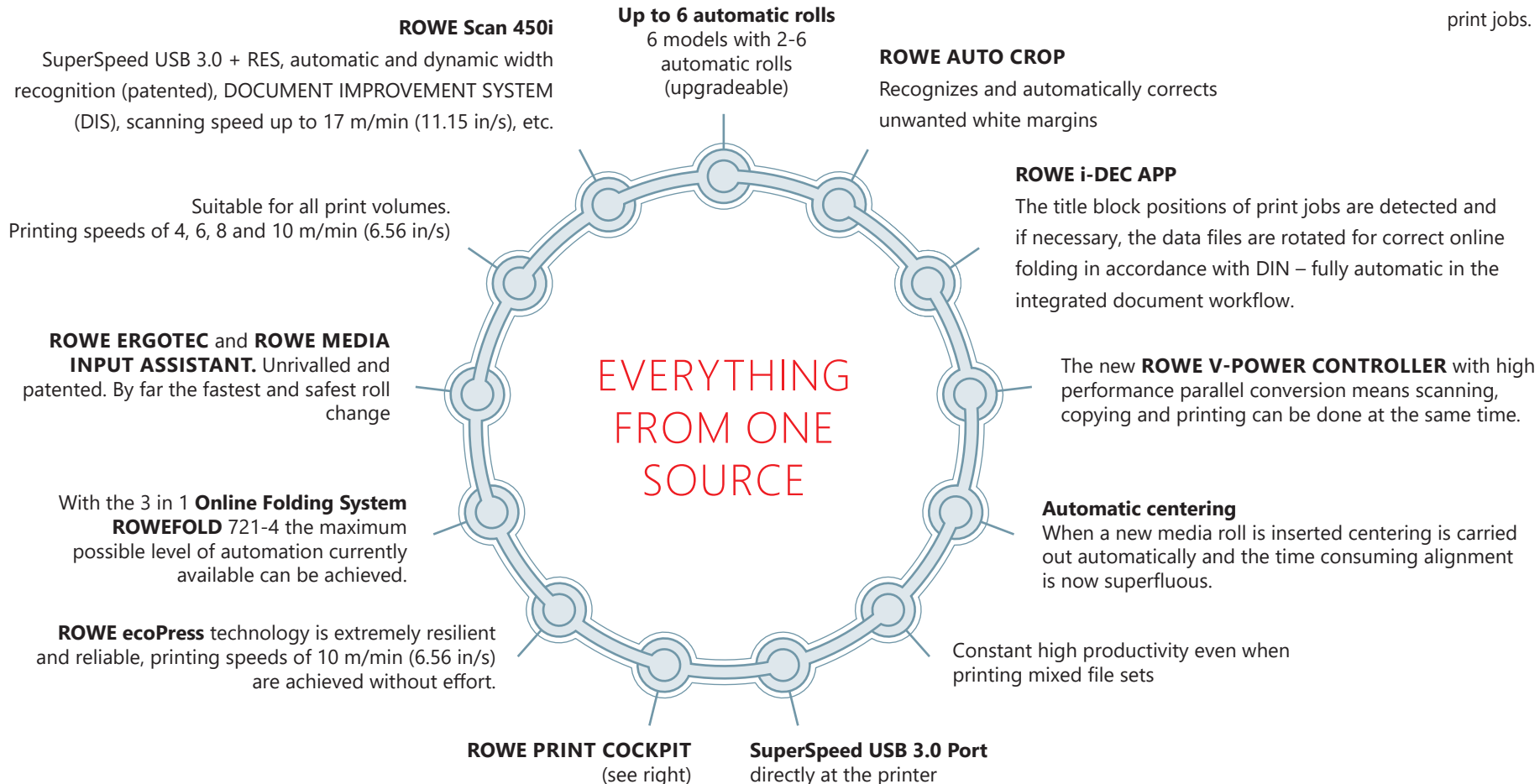

Perfectly in view

ROWE PRINT COCKPIT

Whether directly at the printer or via network, the ROWE PRINT COCKPIT informs in real time about the system status (e.g. display of remaining length of all media rolls) and the job list about the progress of the print jobs.

ecoPrint: i8
Ready

Offline

Media

Roll 1:
Width: 841 mm
Type: Paper
Length: 45 m

Roll 2:
Width: 841 mm
Type: Paper
Length: 34 m

Roll 3:
Width: 297 mm
Type: Paper
Length: 44 m

Roll 4:
Width: 914 mm
Type: Paper
Length: 12 m

Settings

Cancel

Shutdown

Counter:
156 m²
155 m

Firmware: 1.5.0

16:14
26.05.2016

1 ROWE automates your workflow

4 Hot Keys on the operating panel of the ROWE Scan 450i automate your workflow. A variety of functions can be bundled – according to your requirements – and called up at the press of a button.

Visionary ROWE

There are no limits in the use of the Hot Keys. All functions of the ROWE SCAN APP can be stored.

2 ROWE SAFE DRIVE

Transports fragile documents safely and effectively reduces soiling and wear of the scan glass

3 Active Delivery

Driven transport rollers at the back guarantee the safe delivery of the original. No jam in the scanner

4 Simple replacement of the scan glass

Removal of the scan glass is carried out **without tools** – simply, quickly and absolutely ergonomically! It's done like this: open the top part of the scanner, press the scan glass down with your thumb and remove it – finished.

Simple and ergonomical – typical ROWE

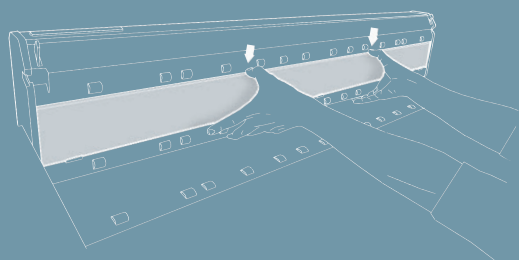

Scan-to: Net, USB, Copy, E-Mail and cloud

FIRST CLASS **ERGONOMICS** IN EVERY DETAIL.

ROWE sets the benchmark in ergonomics. Once again.

The space saving 2 in 1 solution

The ROWE FRONT DELIVERY TRAY becomes a scan delivery tray simply by tilting it back.





- ROWE FULL HD USER-INTERFACE with a 23" or 24" multifunctional touchscreen
- Rotating and tilting
- 2 viewers (overview and main)
- ROWE PRINT COCKPIT



SuperSpeed
USB 3.0 Port



ROWE ERGOTEC

For ease of operation and durability ROWE ERGOTEC is the benchmark:

- The paper is automatically drawn into the printer by the easy feed and a strip is cut from the roll as required.
- Smooth running parallel drawer system
- Buffers
- Whisper-quiet operation

Compare ROWE ERGOTEC with standard drawer systems!
The difference will convince you!

ROWE MEDIA INPUT ASSISTANT (patented)

The safest, most ergonomical and fastest roll change in the market

Advantages at a glance:

- No roll holders – your back is protected
- Automatic centering of the media roll – no alignment of the media on roll holders
- Fastest media exchange
- Safest media exchange, roll is put directly in the ROWE MEDIA INPUT ASSISTANT
- Complicated handling of roll holders is now eliminated: no lifting, pulling out, intermediate storage, insertion, alignment of the media on roll holders etc.

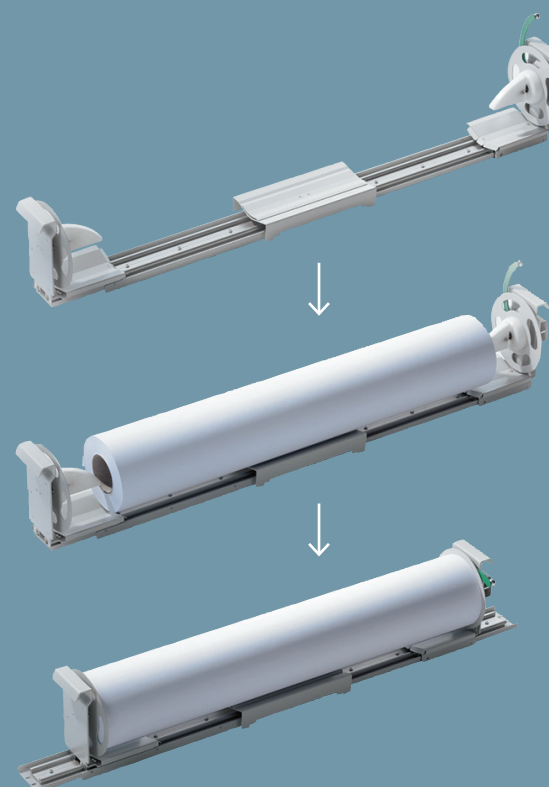

Fastest media change:

Insert new roll ...

... slide the ROWE MEDIA INPUT ASSISTANT together and shift the lever – finished!

Conventional input technology
with roll holders



ROWE ScanMatrix⁺

UNIQUE, PATENTED TECHNOLOGY FOR THE BEST SCAN QUALITY.

ROWE ScanMatrix⁺ consists of several digital core components. A new scan quality dimension is achieved by their interaction. Just superior. Typically ROWE.

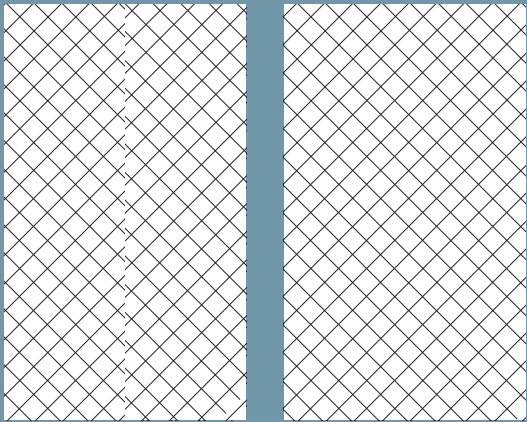

Standard scanner ROWE Scan 450i

■ **ROWE DYNAMIC STITCHING (patented)**
 ROWE engineers have achieved a groundbreaking innovation: excellent scans, even when the document is folded or thin. The patented ROWE DYNAMIC STITCHING continuously controls the scanned document data of each sensor and sets them together in real time. Any deviations that may occur are corrected automatically. Compare the difference!

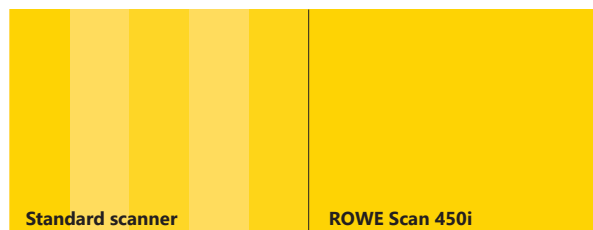

■ **ROWE SELECTED TRUE LIGHT**

The Scan Sensor Technology used for the first time in the ROWE Scan 450i means the lighting of the originals is exceptionally homogenous. This is achieved by the optimal alignment of the lighting angle to the sensor. Together with the ROWE double lens technology, this produces excellent scanning results.

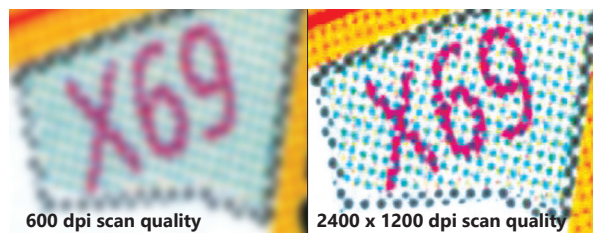

■ **2400 x 1200 dpi**

The optical resolution of 2400 x 1200 dpi (maximum resolution 9600 dpi) means the smallest details are visible. Your competitive edge.

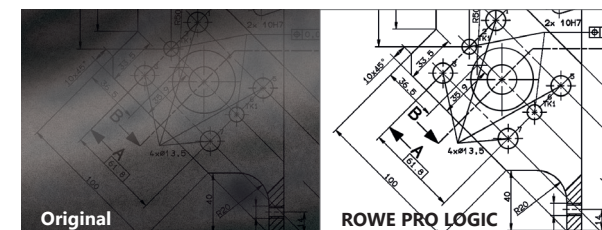

■ **ROWE PRO LOGIC**

The superior document enhancement technology from ROWE for copying and scanning with the “green button”. It ensures that imperfect originals, even those with poor contrast, are turned into perfect scans at the first attempt. This simple job with the “green button” saves valuable time and test scans. Faulty copies are a thing of the past.

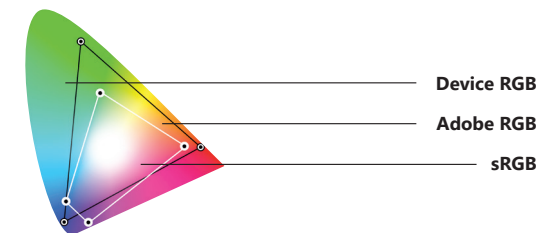

■ **Comprehensive color space support**

The ROWE Scan 450i supports not only the standard sRGB color space but also user defined color spaces like Adobe RGB or Device RGB.

EXCELLENT SCAN PRODUCTIVITY.

The heart of the new ROWE Scan 450i is company technology protected by patents. It's the base for superior productivity. Your competitive edge.

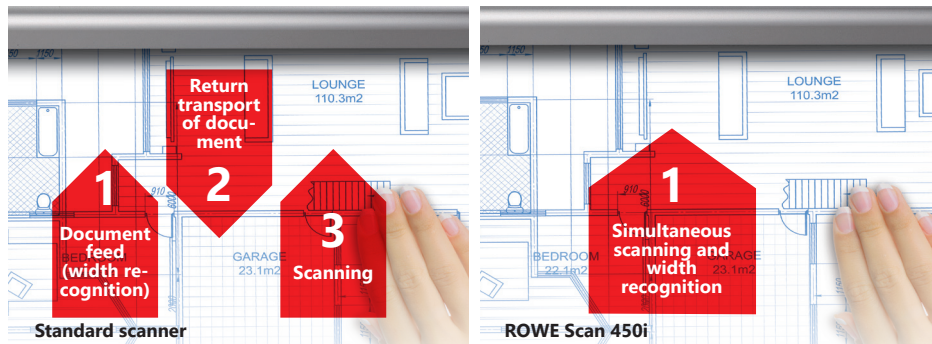

■ Automatic Width Recognition "On the fly" (patented)

ROWE has eliminated the annoying forward and backward movement for recognition of the document width. "On the fly", means that during the scan process the width of the document is detected precisely. This protects your documents and effectively saves time.

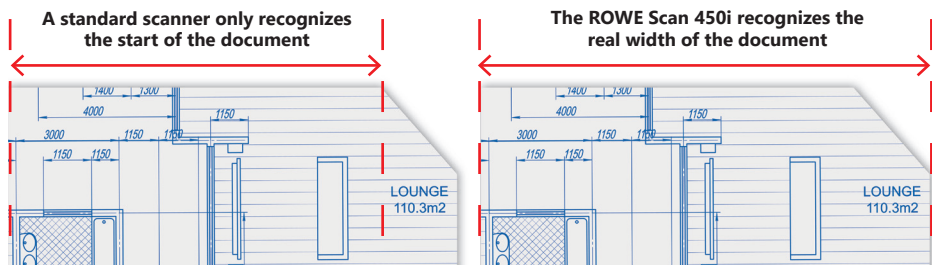

■ Dynamic Width Recognition (patented)

Are the corners of the document damaged or ripped? No problem, the dynamic width recognition of ROWE recognises this and determines the correct width of the document.

SuperSpeed USB 3.0 + ROWE EFFICIENT SCANNING (RES) = Exceptional productivity

■ Only ROWE combines **RES** – a high performance process of data compression without loss - with **SuperSpeed USB 3.0**. **The result:** data throughput increases up to **1000%** compared to HighSpeed USB 2.0! Of course, the ROWE Scan 450i still supports HighSpeed USB 2.0.

1000 %

ROWE Scan 450i with
ROWE SuperSpeed USB 3.0
and ROWE
EFFICIENT SCANNING

100 %

Standard scanner with
HighSpeed USB 2.0

Data throughput at 600 x 600 dpi in full color, format A0 (E-size)

Even compared to Gigabit Ethernet, ROWE SuperSpeed USB 3.0 is up to 300% faster.

■ Immediately operational

As a result of highly efficient LED-light sources a warm-up phase isn't necessary, the ROWE Scan 450i is immediately operational – **also in color**. This saves time, energy and reduces the running costs.

■ DOCUMENT IMPROVEMENT SYSTEM (DIS)

After scanning, can brightness, contrast or color for example be adjusted **without rescanning the document**? No problem, with the DOCUMENT IMPROVEMENT SYSTEM from ROWE! All changes will be immediately displayed in the viewer.

TOP LEVEL CONTROLLER AND SECURITY.



Top performance and reliability with 100% modularity.

ROWE V-POWER CONTROLLER embedded

The new **Visualization** Technology of the embedded ROWE V-POWER CONTROLLER is the solution for your workflow and performance issues. With an integrated 64-bit operating system for 32-bit and 64-bit environments it offers intelligent functions based on APP technology. Now you can deal with the most complex tasks simply, quickly and reliably knowing the process is safe. Simultaneous data conversion ensures concurrent printing, copying and scanning of single documents and sets. Your productivity is visibly increased.

Security

The embedded ROWE V-POWER CONTROLLER ensures the protection of your data from transmission to processing up until it is finally deleted. The controller supports the latest security functions from HTTPS, VPN up to E-DATA SHREDDING and can be individually adapted to meet your requirements. Additionally, the embedded ROWE V-POWER CONTROLLER provides extended protection and logging functions for administrators (e.g. security audits).

Secure printing with PIN code protection

In order to ensure that confidential documents don't land in the hands of unauthorized personnel printouts can be secured with a PIN code. Simply activate the function **Safe Printing** and secure the print order with a PIN code. At the printer simply enter your PIN code and your order will be printed whilst you're there.

Follow-Me-Printing Interface

The ROWE V-POWER CONTROLLER also offers an SNMP interface for integration of ROWE ecoPrint, e.g. in a Follow-Me-Printing System or in a centralized printer management.



UNMATCHED ENVIRONMENTAL FRIENDLINESS.



Sustainability

The focal point of the development of the new ROWE ecoPrint was the endeavor to harmonize technology, mankind and nature. For this, ROWE has developed technologies which are geared to health, protection of resources, environmental protection and durability.

Energy Star

The ROWE ecoPrint has been awarded the Energy Star – our contribution to low energy costs and treating the environment in a way that protects resources.

Almost without ozone emission

The exemplary low level ozone emissions of the ROWE ecoPrint are clearly below the permitted levels. Optimal for the office environment – our contribution to your health.

ROWE ecoToner. Clean toner management tested for harmful substances

Original ROWE ecoToner is tested for harmful substances. The ecoToner management developed by ROWE provides best level print quality for crystal clear lines, homogenous grey and solid black areas. The innovative ROWE toner management is a responsible approach to the environment starting with the toner tested for harmful substances through to the clean and closed toner system with recyclable cartridges.

Low CO₂ emissions in each product life cycle – from the development, sourcing of raw materials, production, distribution and use by the customer up to recycling - a ROWE principle.

Leader in recyclability

The ROWE recycling program leads with hardware which is up to 98% recyclable. The remaining 2% is non-toxic waste. The toner cartridges consist of high quality plastic which is 100% recyclable.

Made in Germany

ROWE produces 100% in Germany. The production is strictly monitored and is carried out according to highest quality criteria.



ROWEFOLD 721-4. THE 3 IN 1 ONLINE FOLDING SYSTEM.

Your ROWE ecoPrint can be extended at any time by the exclusive 3 in 1 Online Folding System from ROWE. Maximum reliability leaves no room for compromise. That's why ROWE develops and produces the complete Folding System itself. This ensures all modules are perfectly tuned to one another.



With the ROWEFOLD 721-4 you get 3 Folding Systems in one and additionally save a lot of space.

1. Fully integrated Online Folding System

Optional with automatic tab applicator, puncher and endless folding (patented)

2. Complete Offline Folding System

- PREMIUM MANUAL FEED with soft feed for safe folding
- Separate operating panel for manual folding
- Highly productive (18 m/min, 59.05 ft/min)
- Automatic interruption of print jobs when manual feed is in use
- Adjustable feed ruler

3. Sorter

Unique in the market: up to 3 delivery trays for optimal sorting and high stacking capacity. Each delivery tray can be individually selected and monitored.

ROWE i-DEC APP

Intelligent: The title block positions of print jobs are detected and if necessary, the data files are rotated for correct online folding in accordance with DIN – fully automatic in the integrated document workflow.

ACCESSORIES. ROWE ecoPrint.

ARTICLE	DESCRIPTION	ROWE ecoPrint	
ROWE FRONT DELIVERY TRAY	Integrated top delivery tray for up to 100 A4-A0 (A - E-size) printouts, requires no additional space, can also be used as a scan delivery tray simply by tilting it back (standard delivery tray not applicable)	all models	o
ROWE ERGOTEC 1 roll drawer	Roll drawer with 3rd roll und ROWE MEDIA INPUT ASSISTANT (patented)	i4	o/+
ROWE ERGOTEC 2 roll drawer	Roll drawer with 3rd + 4th roll und ROWE MEDIA INPUT ASSISTANT (patented)	i6	o/+
Multifunctional touchscreen	23" or 24" multifunctional touchscreen for ROWE FULL HD USER-INTERFACE, resolution 1920 x 1080 pixels and HDMI interface	all models	o/+
ROWE SOLID PRINT TECHNOLOGY	Even large continuous black areas are printed uniformly – no loss of print quality even with high volumes.	all models	o
ROWE High Volume Stacker	Stacker for high volumes A4-A0 (A - E-size) – no power connection necessary	all models	o/+
ROWE Scan 450i 36"	Scan width 36", optical resolution 2400 x 1200 dpi, ROWE ScanMatrix ⁺ , SuperSpeed USB 3.0, automatic and dynamic width recognition, DOCUMENT IMPROVEMENT SYSTEM (DIS), ROWE SAFE DRIVE, etc.	all models	o/+
Online Folding System VarioFold Compact, ROWEFOLD 721-4	721-4: 3 in 1 Folding System, online + offline + sorting, automatic tab applicator, puncher and endless folding (patented) VarioFold Compact: 2 in 1 Folding System, modular construction, on- and offline in one system, endless folding (patented)	all models	o/+
ROWE Sorter	2 or 3 delivery trays for optimal sorting and high stacking capacity. Each delivery tray can be individually selected and monitored.	all models	o/+
Offline Folding System VarioFold Compact, ROWEFOLD 721-1	Suitable for all folding volumes. Can be extended from offline to online, height-adjustable Floorstand makes it easy on the back of the user (VarioFold Compact), endless folding (VarioFold Compact, 721-1), automatic tab applicator, delivery belt (721-1)	all models	o/+



ROWE ERGOTEC 2 roll drawer



ROWE FRONT DELIVERY TRAY



VarioFold Compact offline configuration



VarioFold Compact online configuration

KEY: o/+ Accessory equipment, upgradeable o Additional equipment

TECHNICAL DATA. ROWE ecoPrint.

FEATURES	DESCRIPTION	i4	i6	i8	i10	i8L	i10L
Technology							
Product description	First completely modular black and white large format printer, extendable at any time to multifunctional All-in-One-System (printing, copying, scanning)	✓	✓	✓	✓	✓	✓
Imaging technology	Electrophotography (LED), organic photoconductor (OPC), clean, closed toner system, ROWE ecoPress fusing technology	✓	✓	✓	✓	✓	✓
Print speed	Meters per minute / A1 (ANSI D) per minute	4/5.5	6/8.0	8/10.8	10/12.5	8/10.8	10/12.5
Color scanner							
ROWE Scan 450i (see www.rowe.de for complete technical data)	Scan width 36" (927 mm), optical resolution 2400 x 1200 dpi, ROWE ScanMatrix ⁺ , color depth 48 bit color, 16 bit grayscale, SuperSpeed USB 3.0 + RES, scanning speed up to 17 m/min (11.15 in/s), scan length not limited by scanner, ROWE SELECTED TRUE LIGHT, ROWE DYNAMIC STITCHING - RDS (patented), ROWE PRO LOGIC, ROWE SAFE DRIVE (patented), automated workflow (4 freely programmable Hot Keys on the operating panel of the scanner), automatic width recognition "On the fly" (patented), dynamic width recognition (patented), DOCUMENT IMPROVEMENT SYSTEM (DIS)	o / +	o / +	o / +	o / +	o / +	o / +
Media handling							
Number of automatic media rolls	2 automatic rolls and single sheet feed	✓	✓	✓	✓	✓	✓
	3rd automatic roll	o / +	-	-	-	-	-
	3rd + 4th automatic roll	-	o / +	✓	✓	✓	✓
	5th + 6th automatic roll	-	-	-	-	✓	✓
Media weight	60 - 110 g/m ² (16-28 lb)	✓	✓	✓	✓	✓	✓
Roll width	279 - 914 mm (11"-36"), maximum 175 m (574 ft) per roll	✓	✓	✓	✓	✓	✓
Manual feed	Width: 210 - 914 mm (8.27" - 36"), length: 210 mm - 200 m (8.27" - 7874")	✓	✓	✓	✓	✓	✓
Media type	Paper: plain paper, transparent paper, recycled paper, fluorescent paper, colored paper and vellum; Film: film, polyester	✓	✓	✓	✓	✓	✓
ROWE REMAINING LENGTH DISPLAY	Automatically displays the remaining length of each roll	✓	✓	✓	✓	✓	✓
Standard Delivery Tray	Delivery tray at the back for up to 100 A4-A0 (A - E-size) printouts	✓	✓	✓	✓	✓	✓
ROWE FRONT DELIVERY TRAY	Integrated top delivery tray for up to 100 A4-A0 (A - E-size) printouts, requires no additional space, can also be used as a scan delivery tray simply by tilting it back (standard delivery tray not applicable)	o	o	o	o	o	o
Ergonomics							
ROWE ERGOTEC	Innovative, ergonomic drawer system with easy runners, parallel balance, buffered stops, whisper quiet operation	✓	✓	✓	✓	✓	✓
ROWE MEDIA INPUT ASSISTANT (patented)	Safest, most ergonomic and fastest media input system, without roll holders, simple to operate	✓	✓	✓	✓	✓	✓
ROWE FULL HD USER-INTERFACE	Resolution: 1920 x 1080 pixels	o / +	o / +	o / +	o / +	o / +	o / +
	23" - 24" multifunctional touchscreen Support arm for touchscreen and other flatscreens, screen size 23" - 24" (max. 10 kg/22 lbs) with VESA MISO 75/100 holder. Display optimization: vertical (- 90 to + 90 degrees) and horizontal (- 40 to + 40 degrees). The support arm can also be turned (- 75 to + 75 degrees).	✓	✓	✓	✓	✓	✓
SuperSpeed USB 3.0 - Port directly at the printer	Printing directly from USB stick, scanning directly to USB stick	✓	✓	✓	✓	✓	✓
Print quality							
ROWE HIGH-Q-PRINT/resolution	Print resolution 1200 x 600 dpi, highly developed image processing, crystal clear lines, clear grayscale reproduction	✓	✓	✓	✓	✓	✓
ROWE SOLID PRINT TECHNOLOGY	Even large continuous black areas are printed evenly – no decrease in the quality of the print even with high volumes.	o	o	o	o	o	o
ROWE ecoPress	Fusing quality with flat printed images that can hardly be felt, optimal toner adhesion even when documents are folded	✓	✓	✓	✓	✓	✓
Embedded ROWE V-POWER CONTROLLER							
Platform	ROWE V-POWER CONTROLLER with integrated 64-bit operating system and virtual image processing system for 32-bit and 64-bit environments, web based with high performance simultaneous data conversion, concurrent scanning, copying and printing of individual documents or sets	✓	✓	✓	✓	✓	✓
Interfaces	Ethernet 10/100/1000 MBit/s with RJ45	✓	✓	✓	✓	✓	✓
Scan and print boxes	Local and remote boxes for direct storage of scans or for printing data files (listener function) with settings that can be configured individually, password protected (can be set)	✓	✓	✓	✓	✓	✓
Security	E-data shredding, HTTPS and VPN Extended protection and logging functions for administrators	✓	✓	✓	✓	✓	✓
Secure Printing	PIN code protection, Follow-Me-Printing Interface	✓	✓	✓	✓	✓	✓
ROWE DATA SAFE ⁺	Integrated system security with Live and Backup System	✓	✓	✓	✓	✓	✓
Supported client operating systems	Certified ROWE Windows driver for Windows XP, Windows Vista, Windows 7, Windows 8, Windows 8.1, Windows 10, Windows Server 2003, 2008, 2008 R2 and 2012 (all in 32-bit and 64-bit); ROWE PostScript 3 drivers for Windows XP, Windows Vista, Windows 7, Windows 8 and Windows Server 2003, 2008, 2008 R2 and 2012 (all in 32-bit and 64-bit); platform independent ROWE web tools optimized for Windows Internet Explorer and Mozilla Firefox	✓	✓	✓	✓	✓	✓

KEY: ✓ Standard equipment
o / + Accessory equipment, upgradeable
o Additional equipment
- Not available

FEATURES	DESCRIPTION	i4	i6	i8	i10	i8L	i10L
Data format	HPGL, HPGL2, HPRTL, TIFF, G1, G2, G3, G4, Packed Bits, CALS 1 and 2, TAPE9, LZW, Multipage TIFF, Calcomp 906/907, HCBS, PNG, JPEG, CGM PostScript Level 2 and 3, PDF, PDF-A, Multipage PDF/PDF-A	✓ o / +	✓ o / +	✓ o / +	✓ o / +	✓ o / +	✓ o / +
Network protocols	TCP/IP, SMB, FTP, LPD, SNMP, WebDAV	✓	✓	✓	✓	✓	✓
ROWE APP CENTER							
ROWE COCKPIT APP	Printer status with direct feedback, roll information (width, medium, remaining length), counter, system set up, switch off and new start in remote process	✓	✓	✓	✓	✓	✓
ROWE PRINT APP	Order transmission: web based clients, cloud, USB, preview, ROWE AUTO CROP (recognizes and automatically corrects unwanted white margins) Order management: personalized, intelligent job management with progress, queue management, preview and processing function Additional PRINT QUEUES: for printing, list of printers supported and file printers available on request	✓ ✓ o / +	✓ ✓ o / +	✓ ✓ o / +	✓ ✓ o / +	✓ ✓ o / +	✓ ✓ o / +
ROWE COST TRACKER APP	Protocol of all print, scan and copy orders	✓	✓	✓	✓	✓	✓
ROWE TWAIN APP	Twain + Edit Functions: direct scanning in all applications with Twain support, basic kit image processing, 2 viewers (over and main), ICC color management, ROWE Scan 450i 36" embedded required	✓	✓	✓	✓	✓	✓
ROWE SCAN APP	Twain + Edit + Scan Functions: ROWE TWAIN APP and in addition intuitive operation via touchscreen or mouse and keyboard, Scan-to-Net, Scan-to-USB, Scan-to-E-Mail, Scan-to-Cloud, Scan-to-Box, ROWE Scan 450i 36" embedded required	✓	✓	✓	✓	✓	✓
ROWE COPY APP	Twain + Edit + Scan + Copy Functions: ROWE TWAIN APP, ROWE SCAN APP and in addition Scan-to-Copy, Multiprint, Multitasking, Recopy, Closed-Loop color calibration, a printer driver for both inkjet printer and ROWE printer, ROWE Scan 450i 36" embedded required Additional COPY DRIVERS: for copying, list of printers supported available on request	✓ o / +	✓ o / +	✓ o / +	✓ o / +	✓ o / +	✓ o / +
ROWE FOLD APP SE/PRO	Set-up and editing of folding programs, Folding System ROWEFOLD 721-4 required or ROWE VarioFold Compact	✓	✓	✓	✓	✓	✓
ROWE WEB CONNECT APP	Platform independent web access, scanning in the cloud, printing from the cloud	✓	✓	✓	✓	✓	✓
ROWE EDIT PROFESSIONAL APP	Functions: two point deskew, measurement of areas and distances directly in the scan, cleaning, insertion of text and geometrical shapes, various layers, transparent objects, generation of color palettes, extended cutting functions	o / +	o / +	o / +	o / +	o / +	o / +
ROWE POSTSCRIPT/PDF APP	Direct printing of PostScript Level 2 and 3, PDF, PDF-A, MULTIPAGE PDF/PDF-A data files on ROWE ecoPrint	o / +	o / +	o / +	o / +	o / +	o / +
ROWE PRINT SPECIALS APP	Editing of stamps, texts in margins, cover pages and pens	o / +	o / +	o / +	o / +	o / +	o / +
ROWE COST CENTER APP	Comprehensive cost management with calculation, limitation and filter functions. Prepaid, user and cost accounts, including forced accounting (on or off function)	o / +	o / +	o / +	o / +	o / +	o / +
ROWE i-DEC APP	Automatic detection of title block positions and rotation of data files for correct online folding in accordance with DIN	o / +	o / +	o / +	o / +	o / +	o / +
Environment							
ROWE ecoToner	Toner tested for harmful substances Clean and closed toner system	✓ ✓	✓ ✓	✓ ✓	✓ ✓	✓ ✓	✓ ✓
Power consumption (watts) better than required by Energy Star	Energy saving mode with programmable timer, incl. controller Printing mode	1200	1350	1450	1550	1450	1550
Power supply	220/230 V, 50/60 Hz	✓	✓	✓	✓	✓	✓
Sound power level in db (in acc. with ISO 7779 operator position)	Energy saving mode, incl. controller Printing mode	52	52	52	52	52	52
Ozone concentration	The following measurement results are clearly below the permitted values: <0.0005 mg/m ³ (<0.00025 ppm) average	✓	✓	✓	✓	✓	✓
Printer recycling	Manufactured in steel or high quality recyclable plastics: up to 98 % of the unit can be recycled. The remaining 2 % is non-toxic waste.	✓	✓	✓	✓	✓	✓
Toner cartridge recycling	Cartridge made of completely recyclable plastic	✓	✓	✓	✓	✓	✓
Weight	Weight printer in kg/lbs - 2 rolls Weight printer in kg/lbs - 3 rolls Weight printer in kg/lbs - 4 rolls Weight printer in kg/lbs - 6 rolls Weight ROWE FRONT DELIVERY TRAY in kg/lbs	276/608 312/687 - - 7/15,4	276/608 - 334/736 - 7/15,4	- - 334/736 - 7/15,4	- - 334/736 - 7/15,4	- - - 407/897 7/15,4	- - - 407/897 7/15,4
Dimensions	Width/Height/Depth in mm with ROWE FRONT DELIVERY TRAY, without multifunctional touchscreen		1374 (54.1")/ 1408 (55.43")/ 759 (29.88")			1374 (54.1")/ 1640 (64.57")/ 759 (29.88")	
Certifications	RoHS, ENERGY STAR, CE, CCC, UL, cUL, CB, FCC Part 15 Class B, EAC, BIS	✓	✓	✓	✓	✓	✓



WIDE FORMAT: ROWE.

WIDE FORMAT: ROWE.

ROWE is the specialist for wide format from Germany, represented in 90 countries. Perfectly coordinated systems for scanning, printing and finishing as well as comprehensive software solutions for professional document workflow are developed and manufactured by ROWE. ROWE has the leading edge worldwide as the specialist and technological leader.



ROTH + WEBER GmbH . Phone: +49 2743 9217-0
57520 Niederdreisbach . Fax: +49 2743 2018
GERMANY

www.rowe.one

Made in Germany. **ROWE ScanMatrix+**



Full Modularity



Copyright: ROTH + WEBER GmbH 2017. All rights reserved. The information contained herein shall be subject to change without notice. ROWE shall not be liable for technical or editorial errors or any omissions contained herein. Product appearance, construction and/or specifications shall be subject to change or amendment without notice. All trademarks remain the property of their respective holders and are used only to describe the respective product. Their use in no way indicates any relationship between ROTH + WEBER GmbH and the holders of the mentioned trademarks. **Juli 2019**